

JUSTIME

JUSTIME | 巧時代



JUSTIME | 巧時代

勝泰衛材股份有限公司
SHENG TAI BRASSWARE CO., LTD.

508 台灣彰化縣和美鎮彰草路3段99號
TEL:04-7629971 FAX:04-7526980

Website:www.justime.com

E-mail:info@justime.com

Facebook:www.facebook.com/JUSTIME



Faucets / Shower Mixer / Bathroom Accessories

2021.08

水龍頭 & 淋浴系統

Pan 1	03-04
Pan 2	05-06
Story	07-08
Dragon	09-10
Yes	11-12
Chapter	13-16
Black	17-18
Lucky 7	19-20
Nature	21-22
埋壁淋浴組	23-28

沖洗器組合	29-30
浴缸龍頭	31-32
長栓龍頭	33-34
感應式龍頭	35-36
工作龍頭	37-40
飲水機龍頭	41-42

浴室配件

Simple	43-44
Still One	45-46
Nature	47
Yes	48
Aurora	49
Mark	50
Charming	51-52
Dragon	53-54
Ether	55-56

臉盆	57-60
馬桶&水箱&面板	61-62
衛生紙架	63-64
浴缸	65-68
手持花灑	69-70
頂噴花灑	71-72
升降桿	73-74
花灑掛架	75-76
地漏	77-80
水道配件	81-82



公司簡介

JUSTIME巧時代衛浴團隊，創立於一九七六年，致力於衛浴建材五金及相關專業產品的研發製造。多年的經驗累積，擁有卓越的製造能力，關係企業廣及台灣、大陸以及泰國，產品遍銷世界，各主要市場包含歐美、亞洲、非洲及大洋洲等各地。

獎項





8765-90-80P1
檯面龍頭組
(附按壓式排水零件)



6765-90-80P1
檯面龍頭
(排水零件至P82挑選)



7765-BD-80P1
淋浴柱



7765-BF-80P1
淋浴柱

標配



7765-93-82P1
淋浴龍頭



7765-94-82P1
淋浴龍頭

淋浴自由選 (A+B+C+D)

A 龍頭



6765-93-80P1
淋浴龍頭本體組
(無下出水)



6765-94-80P1
淋浴龍頭本體組

B 蛇管



1/2" x 1/2"
S150-FP-7903
150cm / 淋浴用
(PVC 軟管)



1/2" x 1/2"
S150-F6-79CP
150cm / 淋浴用
(可伸縮)

C 蓮蓬頭



6808-9S-80CP
五段式圓形手持花灑



6877-H1-80CP
三段式手持花灑

D 掛件



6757-9C-80CP
可調式掛架



6479-9T-80CP
升降桿(管徑22mm)



6759-9T-80CP
升降桿(管徑19mm)



8779-90-80CP
檯面龍頭組
(附按壓式排水零件)



6779-90-80CP
檯面龍頭
(排水零件至P82挑選)



6779-BF-80CP
淋浴柱

標配



6779-93-81CP
淋浴龍頭



6779-94-82CP
淋浴龍頭

淋浴自由選 (A+B+C+D)

A 龍頭



6779-93-80CP
淋浴龍頭本體組
(無下出水)



6779-94-80CP
淋浴龍頭本體組

B 蛇管



1/2" x 1/2"
S150-FP-7903
150cm / 淋浴用
(PVC 軟管)



1/2" x 1/2"
S150-F6-79CP
150cm / 淋浴用
(可伸縮)

C 蓮蓬頭



6808-9S-80CP
五段式圓形手持花灑



6877-H1-80CP
三段式手持花灑

D 掛件



6757-9C-80CP
可調式掛架



6479-9T-80CP
升降桿(管徑22mm)



6759-9T-80CP
升降桿(管徑19mm)



標配



6903-93-81CP
淋浴龍頭



6903-94-81CP
淋浴龍頭

淋浴自由選 (A+B+C+D)

A 龍頭



6903-93-80CP
淋浴龍頭本體組
(無下出水)



6903-94-80CP
淋浴龍頭本體組

B 蛇管



1/2" x 1/2"
S150-FP-7903
150cm / 淋浴用
(PVC 軟管)



1/2" x 1/2"
S150-F6-79CP
150cm / 淋浴用
(可伸縮)

C 蓮蓬頭



6808-9S-80CP
五段式圓形手持花灑



6877-H1-80CP
三段式手持花灑

D 掛件



6757-9C-80CP
可調式掛架



6479-9T-80CP
升降桿(管徑22mm)



6759-9T-80CP
升降桿(管徑19mm)



6903-90-80CP
檯面龍頭
(排水零件至P82挑選)



6903-92-81CP
壁式雙把檯面龍頭



6903-BD-80CP
淋浴柱



6903-BF-80CP
淋浴柱

Dragon Design Legacy, Modern Bathing



6904-X2-80CP
埋壁式單把檯面龍頭



6904-90-80CP
檯面龍頭
(排水零件至P82挑選)



7904-90-80CP
檯面龍頭
(排水零件至P82挑選)



6904-BW-82CP
三出水淋浴龍頭

標配



6904-93-81CP
淋浴龍頭



6904-94-81CP
淋浴龍頭

淋浴自由選 (A+B+C+D)

A 龍頭



6904-93-80CP
淋浴龍頭本體組
(無下出水)



6904-94-80CP
淋浴龍頭本體組

B 蛇管



1/2" x 1/2"
S150-FP-7903
150cm / 淋浴用
(PVC 軟管)



1/2" x 1/2"
S150-F6-79CP
150cm / 淋浴用
(可伸縮)

C 蓮蓬頭



6808-9S-80CP
五段式圓形手持花灑



6877-H1-80CP
三段式手持花灑

D 掛件



6757-9C-80CP
可調式掛架



6479-9T-80CP
升降桿(管徑22mm)



6759-9T-80CP
升降桿(管徑19mm)



6875-J3-80CP
埋壁式雙把淋浴龍頭



6875-JT-80CP
埋壁式溫控龍頭

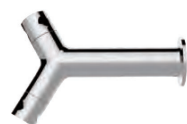

6875-J0-80CP
埋壁式檯面龍頭



6875-90-80CP
檯面龍頭
(排水零件至P82挑選)



7875-90-80CP
檯面龍頭
(排水零件至P82挑選)

標配



6875-93-81CP
淋浴龍頭



6875-94-81CP
淋浴龍頭

淋浴自由選 (A+B+C+D)

A 龍頭



6875-93-80CP
淋浴龍頭本體組
(無下出水)



6875-94-80CP
淋浴龍頭本體組

B 蛇管



1/2" x 1/2"
S150-FP-7903
150cm / 淋浴用
(PVC 軟管)



1/2" x 1/2"
S150-F6-79CP
150cm / 淋浴用
(可伸縮)

C 蓮蓬頭



6808-9S-80CP
五段式圓型手持花灑



6877-H1-80CP
三段式手持花灑

D 掛件



6757-9C-80CP
可調式掛架



6479-9T-80CP
升降桿(管徑22mm)



6759-9T-80CP
升降桿(管徑19mm)

Chapter Chapter of Water



INTERNATIONAL DESIGN EXCELLENCE AWARDS
GOOD DESIGN AWARD
年度グッドデザイン賞

6926-90-80CP
檯面龍頭



6926-96-80CP
廚房龍頭



6926-U7-80MA
感應式龍頭面盆組

6926-U9-80MA
立地式面盆龍頭

6510-U9-8000
立柱盆組(人造石)
Ø430*850mm



標配



7926-T4-83CP
溫控淋浴龍頭



6926-TF-93CP
溫控淋浴龍頭(亮面)

6926-TF-93MA
溫控淋浴龍頭(霧黑)

淋浴自由選 (A+B+C+D)

A 龍頭



7926-T4-80CP
溫控淋浴龍頭本體組



6926-T4-85CP
溫控淋浴龍頭本體組
(含蛇管)

B 蛇管



1/2" x 1/2"
S150-FP-7903
150cm / 淋浴用
(PVC 軟管)



1/2" x 1/2"
S150-F6-79CP
150cm / 淋浴用
(可伸縮)

C 蓮蓬頭



6808-9S-80CP
五段式圓形手持花灑



6877-H1-80CP
三段式手持花灑

D 掛件



6757-9C-80CP
可調式掛架



6479-9T-80CP
升降桿(管徑22mm)



6759-9T-80CP
升降桿(管徑19mm)

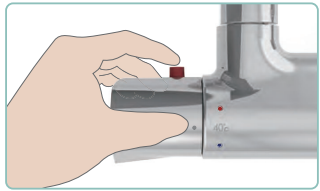

預防過熱鎖定安全鈕

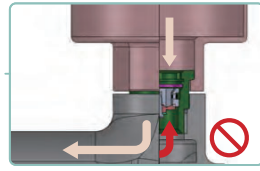

左右兩進水口設有安全逆止閥，可有效防止冷熱水逆流



陶瓷片切換，高度密合，不漏水



特殊可旋轉結構

6926-TD-93CP
溫控淋浴柱

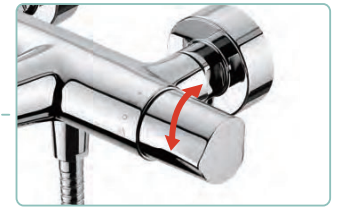

切換把手獨特造型、切換施力更為方便，兼顧設計與實用性。

預防過熱鎖定安全鈕

龍頭旋轉控制出水



切換至下出水

切換至手持花灑出水

獨特出水口旋轉切換結構，切換功能更為直覺，同時出水口與牆面貼實，更為安全。

SMA 恆溫技術

安全又舒適的溫控技術

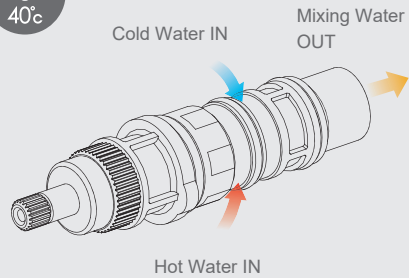

SMA 形狀記憶合金

SMA 形狀記憶合金彈簧與偏置彈簧間的相互平衡作用來調節冷熱水的水壓比例，以保持所選擇的水溫不變，杜絕水溫忽冷忽熱的現象，提升使用安全性，使用時不需要一直調整溫度。

- 感溫速度快
- 高耐久性
- 產品的構成部件少

Black Low-key and Restrained



6765-90-80MA
檯面龍頭(本體)

8765-90-80MA
檯面龍頭(含水道零件全配)



6779-90-80MA
檯面龍頭(本體)

8779-90-80MA
檯面龍頭(含水道零件全配)



6929-M0-80MA
浴缸龍頭
(不鏽鋼)



6926-90-80MA
檯面龍頭
(排水零件至P82挑選)



6923-90-80MA
檯面龍頭
(排水零件至P82挑選)



6919-MA-82MA
浴缸龍頭

標配



7765-94-82MA
淋浴龍頭



6779-94-82MA
淋浴龍頭

淋浴自由選 (A+B+C+D)

A 龍頭



6765-94-80MA
淋浴龍頭本體組



6779-94-80MA
淋浴龍頭本體組

B 蛇管



1/2" x 1/2"
S150-FP-79MA
150cm / 淋浴用
(PVC 軟管)



1/2" x 1/2"
S150-F6-79MA
150cm / 淋浴用
(可伸縮)

C 蓮蓬頭



6808-9S-80MA
五段式圓形手持花灑



6877-H1-80MA
三段式手持花灑

D 掛件



6757-9C-80MA
可調式掛架



6759-9T-80MA
升降桿(管徑19mm)

Lucky 7 Pleasant Surprise



6777-92-81MA
埋壁式雙把檯面龍頭



7777-X2-80MA
埋壁式單把檯面龍頭



6777-90-80MA
檯面龍頭



6757-9S-81MA
花灑含蛇管(150cm)

標配



6777-X3-81MA
淋浴龍頭



6777-X4-81MA
淋浴龍頭

淋浴自由選 (A+B+C+D)

A 龍頭



6777-X3-80MA
淋浴龍頭本體組
(無下出水)



6777-X4-80MA
淋浴龍頭本體組

B 蛇管



1/2" x 1/2"
S150-FQ-79MA
150cm / 淋浴用
(PVC 軟管)



1/2" x 1/2"
S150-F7-79MA
150cm / 淋浴用
(可伸縮)

C 蓮蓬頭



6808-9S-80MA
五段式圓形手持花灑



6877-H1-80MA
三段式圓形手持花灑

D 掛件



6757-9C-80MA
可調式掛架



6759-9T-80MA
升降桿(管徑19mm)



淋浴自由選 (A+B+C+D)

A 龍頭



6927-93-85CP
淋浴龍頭本體+蛇管



6927-94-85CP
淋浴龍頭本體+蛇管



7927-X3-80CP
淋浴龍頭本體組
(不含蛇管)



6927-X4-80CP
淋浴龍頭本體組
(不含蛇管)

B 蛇管



1/2" x 1/2"
S150-FQ-79CE
150cm / 淋浴用
(亮銀PVC軟管)



1/2" x 1/2"
S150-F7-79CP
150cm / 淋浴用
(可伸縮)

C 蓮蓬頭



6808-9S-80CP
五段式圓型手持花灑



6877-H1-80CP
三段式手持花灑

D 掛件



7927-9C-80CP
可調式掛架



6757-9C-80CP
可調式掛架



6927-90-80CP
檯面龍頭
(排水零件至P82挑選)



7927-90-80CP
檯面龍頭
(排水零件至P82挑選)



6927-92-81CP
壁式雙把檯面龍頭



6927-X2-80CP
壁式單把檯面龍頭



6479-9T-80CP
升降桿(管徑22mm)



6759-9T-80CP
升降桿(管徑19mm)

Pan 1



6768-AB-80CP
頂噴花灑L型管



6808-9S-81CP
花灑含蛇管(150cm)



0765-9C-79CP
花灑掛架



6765-XY-80P1
埋壁式閥體組



6765-AD-80CP
出水接頭



6765-9W-80CP
出水口組

Pan 2



6808-9S-81CP
花灑含蛇管(150cm)



6875-9S-81CP
花灑含蛇管(150cm)



6779-AB-80CP
頂噴花灑L型管



6779-DC-81CP
出水接頭含掛架
(附5cm牙管)



6779-XY-80CP
埋壁式閥體組



6779-9W-80CP
出水口組

Story



6903-9S-81CP
花灑含蛇管(150cm)



6903-AB-8007
頂噴花灑+L型管



6903-9C-80CP
花灑掛架



6759-AD-80CP
出水接頭
(附5cm牙管)



6765-9W-80CP
出水口組



6903-Z1-81CP
三把手組(兩出水)

Dragon



6909-9S-81CP
花灑含蛇管(150cm)



6904-AB-80CP
頂噴花灑+L型管



6904-9C-80CP
花灑掛架



6909-AD-80CP
出水接頭
(附5cm牙管)



6904-XY-80CP
埋壁式閥體組



6909-9W-80CP
出水口組

Nature



6920-AB-80CP
頂噴花灑+L型管



6757-9S-81CP
花灑含蛇管(150cm)



7927-9C-80CP
花灑掛架



6927-AD-80CP
出水接頭
(附5cm牙管)



6927-XY-80CP
埋壁式閥體組



6927-X2-78CP
出水口組

Lucky 7

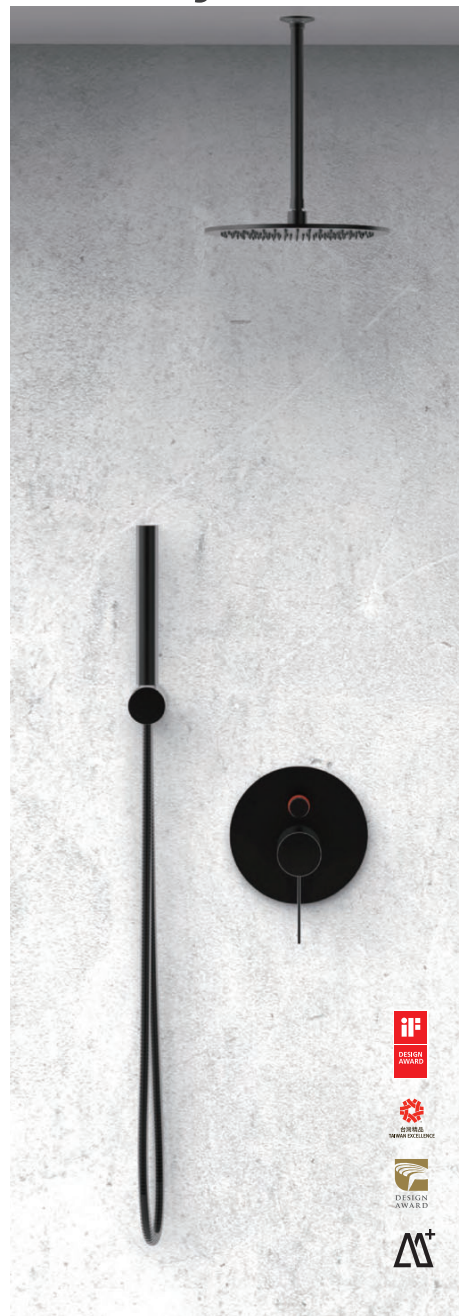

7771-AS-80MA
圓型頂噴花灑



7771-AB-80MA
頂噴花灑+L型管



6877-H1-80MA
三段式圓型手持花灑



6808-9S-80MA
五段式圓形手持花灑



6777-XW-80MA
埋壁式閥體組



6777-9W-80MA
出水口組



1/2" x 1/2"
S150-FQ-79MA
150cm / 淋浴用
(PVC 軟管)



6777-DC-81MA
出水接頭含掛架
(附5cm牙管)



6777-DC-85MA
花灑掛架+花灑



Sprayer



GOOD DESIGN AWARD
年度グッドデザイン賞

獨立水源型



6796-WS-82CP
洗滌器組



6875-LD-80CP
雙出水口開關



6875-YC-81CP
洗滌器組

YES沖洗器組



6903-WS-82CW
洗滌器組



6875-WS-81CP
洗滌器+蛇管+掛架

+



6797-L6-80CP
多功能長柱

共用馬桶水源型



6770-WS-81S1
洗滌器+蛇管+掛架
(不鏽鋼)



6771-WS-81CP
洗滌器+蛇管+掛架



6909-WS-82CP
洗滌器+蛇管+掛架



6875-WS-81CP
洗滌器+蛇管+掛架



6903-WS-81CP
洗滌器+蛇管+掛架

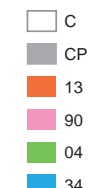

6874-YY-80CR
活動式三通

Bathtub Faucet

檯面式浴缸龍頭



壁式浴缸龍頭



7906-M0-80CP
浴缸龍頭



7906-M2-81CP
浴缸龍頭



6923-M5-80CP
浴缸龍頭



6923-M0-80CP
浴缸龍頭

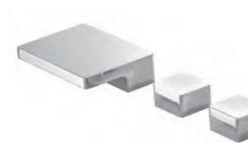

6909-M0-80CP
三件式浴缸龍頭



6909-M2-80CP
五件式浴缸龍頭



6919-MA-82CP
浴缸龍頭



6919-MA-83CP
浴缸龍頭



6929-M0-80PB
浴缸龍頭(亮面)
6929-M0-80S1
浴缸龍頭(霧面)



6929-M2-80PB
五件式浴缸龍頭(亮面)
6929-M2-80S1
五件式浴缸龍頭(霧面)



6765-W0-80P1
壁式浴缸龍頭



6875-W0-80CP
壁式浴缸龍頭



6903-W0-80CP
壁式浴缸龍頭



6904-W0-80CP
壁式浴缸龍頭



6927-W0-80CP
壁式浴缸龍頭



6903-95-85CP
壁式浴缸龍頭

Hose Bib



水管型長栓



6875-L4-80CP
水管長栓



6875-L4-80BB
水管長栓



6875-L4-80MA
水管長栓



6875-L4-80SW
水管長栓



6875-LK-80CP
水管長栓(暗鎖式)



6903-L4-80CP
水管長栓

多功能長栓



6765-L3-80CP
一切二多功能長栓



6779-L3-80CP
一切二多功能長栓



6797-L6-80CP
多功能長栓



6875-L6-80CP
多功能長栓



6875-LD-80CP
雙出水開關



6903-L6-80CP
多功能長栓

轉接頭類



6757-GA-80CP
出水口組(整流片)



6757-GC-80CP
出水口組(起泡頭)



6875-LH-80CR
塑膠水管接頭



6875-QD-8000
洗衣機水管接頭
(快接式)



6875-QD-80CR
洗衣機水管接頭
(快接式)



6875-QG-80CR
花園水管接頭
(快接式)



6875-QG-8029
花園水管接頭
(快接式)



6757-SP-79CP
噴霧器

Sensor Faucet



6777-S7-80MA
感應式水龍頭

感應式水龍頭



6797-S0-80CP
感應式水龍頭



7797-S0-80CP
感應式水龍頭



6781-S0-80CP
感應式水龍頭



6797-S5-80CP
感應式水龍頭



6703-S5-80CP
感應式水龍頭



6927-S5-80CP
感應式水龍頭



5790-S0-80CP
感應式水龍頭



6923-S0-80CP
感應式水龍頭



9779-S0-80CP
感應式水龍頭



6390-G0-8300
小便斗+感應器
(100-240V)

6390-G0-7900
小便斗

6390-S0-8300
小便斗感應器
(100-240V)



S030-FF-7900
高壓編織管/雙母
1/2" x 1/2" (不銹鋼)
(30CM)



6995-16-80CR
冷熱閥本體組
A: M15*1.0

電壓

110V
220V
100-240V

電源插頭

0923-SH-7901
0923-SH-7902
0923-SH-7900

此頁感應式龍頭產品
可加購AC電源插頭

Working Faucet

工作龍頭



6928-PU-8035
抽拉式廚房龍頭

抽拉式廚房龍頭



6926-PU-80CP
抽拉式廚房龍頭



6926-PU-80KG
抽拉式廚房龍頭



6926-PU-80MA
抽拉式廚房龍頭



6928-PU-80MK
抽拉式廚房龍頭



6928-PU-805K
抽拉式廚房龍頭



6780-PU-80CP
抽拉式廚房龍頭



6770-97-80S1
廚房龍頭(不鏽鋼)



6771-97-80CP
工作龍頭



6780-96-80CP
工作龍頭



6772-97-82S1
廚房龍頭(不鏽鋼)



6771-97-82CP
工作龍頭



6780-96-82CP
工作龍頭



6922-X6-80CP
工作龍頭



6904-96-80CP
工作龍頭



6926-96-80CP
工作龍頭



6922-X6-82CP
工作龍頭



6904-96-82CP
工作龍頭



6765-96-80P1
工作龍頭



6777-X6-80CP
工作龍頭



6777-96-80CP
工作龍頭



6765-95-80P1
工作龍頭(壁式)

工作龍頭

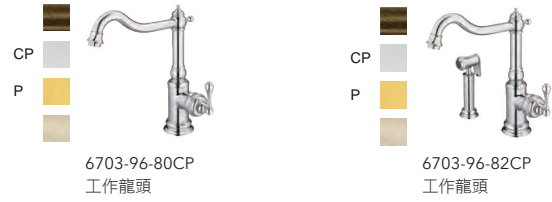

Water Drinking Faucet



飲水機龍頭



6703-G0-80CP
飲水機龍頭
(無鉛銅)



6770-G0-80S1
飲水機龍頭
(不鏽鋼)



6771-G0-80CP
飲水機龍頭
(無鉛銅)



6777-G0-80CP
飲水機龍頭
(無鉛銅、冷水)
6777-G1-80CP
(無鉛銅、熱水)



6777-G2-80CP
飲水機龍頭
(無鉛銅、熱水&冷水)
釋放開關，同時關閉熱水



7780-G5-80CU
飲水機龍頭
(抗菌銅)
按壓出水



6808-G0-80CU
飲水機龍頭
(抗菌銅)



7780-G5-80S1
飲水機龍頭
(不鏽鋼)
按壓出水

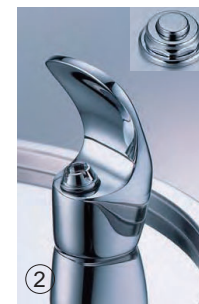

① 6710-04-81CP
按壓式/飲水機龍頭
(無鉛銅)

② 6741-01-81CP
按壓式/飲水機龍頭
(無鉛銅)

③ 6783-G1-80CP
按壓式/飲水機龍頭
(無鉛銅)



6810-50-80CP
掛勾



6810-52-80CP
掛勾



6810-41-80CP
有蓋衛生紙架



6810-60-80CP
浴巾環



6810-DS-80CP
門擋



6810-70-80CP
置物平台(60cm)



6810-55-80CP
扶手架(30cm)



6810-56-80CP
扶手架(45cm)



6810-58-80CP
弓形扶手架



6810-10-81CP
毛巾架(60cm)



6810-66-80CP
置物架附毛巾桿組(60cm)



6810-81-80CP
馬桶刷組

Stainless Steel 不鏽鋼



6806-10-80S1
毛巾架(60cm)



6806-41-80S1
有蓋衛生紙架



6806-88-81S1
轉角籃



6806-73-80S1
置物平台(35cm)



6806-52-80S1
掛勾



7806-66-80S1
置物架附毛巾桿組(60cm)

Brass 銅



6807-10-80CP
毛巾架(60cm)



6807-41-80CP
有蓋衛生紙架



6807-88-81CP
轉角籃



6807-73-80CP
置物平台(35cm)



6807-52-80CP
掛勾



7807-66-80CP
置物架附毛巾桿組(60cm)



Nature Attractiveness of Asymmetry



6927-10-80CP
毛巾架
(C/C 60cm)



6927-70-80CP
平台組



6927-40-80CP
衛生紙架



6927-41-80CP
平台捲紙架



6927-52-80CP
掛勾



6927-74-80CP
三角平台

YES Lines & Cylinder

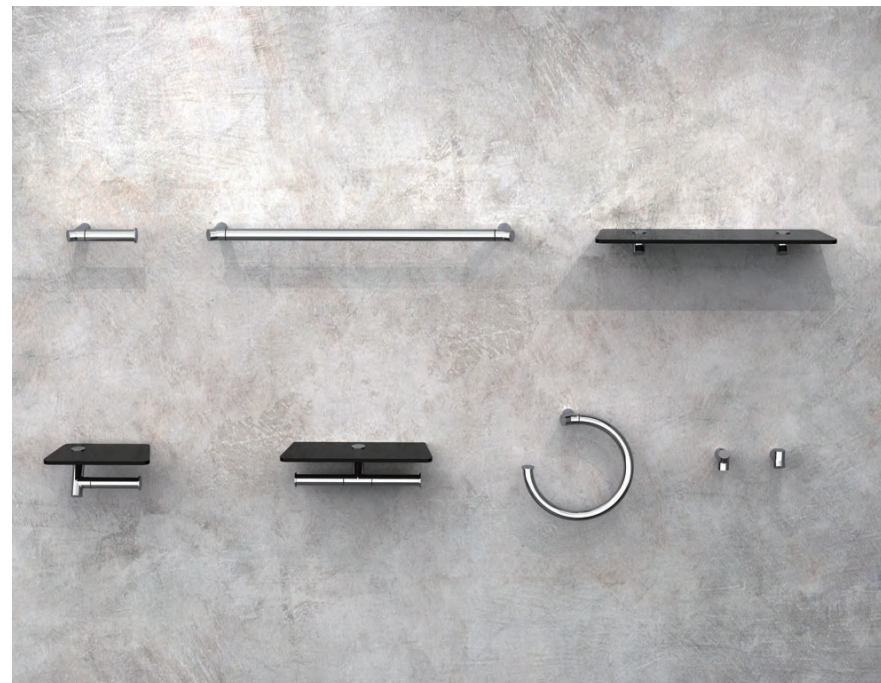

7875-10-80CP
毛巾架
(C/C 60cm)



7875-70-80CP
置物平台
(L50*W13cm)



7875-41-80CP
平台捲紙架
(L23*W13cm)



7875-42-80CP
平台雙捲紙架
(L33*W13cm)



7875-40-80CP
衛生紙架



7875-50-80CP
掛勾



7875-60-80CP
浴巾環

Aurora Lasting Eternity



Mark The Mark of Quality



6899-10-80S1
毛巾架(60cm)



6899-27-80S1
擠皂罐



6899-41-80S1
有蓋衛生紙架



6909-10-80CP
毛巾架(60cm)



6909-41-80CP
有蓋衛生紙架



6909-60-80CP
浴巾環



6899-66-80S1
置物架附毛巾桿組(60cm)



6899-51-80S1
掛勾



6899-80-80S1
馬桶刷組



6909-66-80CP
置物架附毛巾桿組(60cm)



6909-51-80CP
掛勾



6909-80-80CP
馬桶刷組

Charming

The Charm Is In The Detail



台灣精品
TAIWAN EXCELLENCE

MA CP W1



6922-5X-80MA
扶手架(25cm)



6922-D6-80MA
淋浴拉門把手組
(45cm & 15cm)



6922-20-80CP
肥皂架



6922-22-80CP
橫桿式肥皂架



6922-35-80CP
牙刷架



6922-50-80CP
掛勾



6922-11-80CP
毛巾架(30cm)



6922-10-80CP
毛巾架(60cm)

6922-13-80CP
毛巾架(76cm)



6922-14-80CP
雙毛巾架(60cm)

6922-15-80CP
雙毛巾架(76cm)



6922-65-80CP
置物架(60cm)



6922-66-80CP
置物架含毛巾桿組(60cm)



6922-40-80CP
衛生紙架



open

Dragon Design Legacy, Modern Bathing



6904-10-81MA
毛巾架(不對稱)



6904-20-80MA
肥皂盤組



6904-25-80MA
擠皂罐組



6904-40-80MA
衛生紙架



6904-43-80MA
備用衛生紙架



6904-50-80MA
掛勾



6904-10-80MA
毛巾架



6904-30-80MA
漱口杯組



6904-35-80MA
牙刷架



6904-51-80MA
掛勾



6904-60-80MA
浴巾環



6904-K0-80MA
抽屜把手

Ether

Attractiveness of Asymmetry



6781-10-80CP
毛巾架
400*127*43mm



6781-70-80CP
置物平台
400*127*43mm



6781-20-80CP
肥皂架



6781-30-80CP
漱口杯組



6781-40-80CP
衛生紙架



6781-50-80CP
掛勾



6781-51-80CP
掛勾



6781-60-80CP
浴巾環

Basin



年度グッドデザイン賞



檯面式臉盆



6510-05-80CP
(玻璃臉盆含襯墊)
400*155mm



6510-G0-8000
410*410*120mm



6510-G3-80CP
500*500*150mm



6510-T3-8000
430*430*120mm



6510-T5-8000
665*440*145mm



6510-G5-80CP
650*440*210mm

吊壁式臉盆



立柱盆
6513-B0-8200
510*420*780mm



立柱盆
6513-B0-8100
515*430*470mm



圓腳
6515-F1-8000
555*470*390mm
6515-F2-8000
460*420*325mm



方腳
6515-F3-8000
560*460*375mm
6515-F4-8000
440*425*330mm



6510-M4-8000
550*355*150mm



6510-H4-80CP
460*460*140mm



6510-T1-8000
470*360*145mm



6510-G6-80CP
570*440*130mm



0510-G7-4100
400*400*120mm



6510-T6-8000
400*400*120mm

檯面式臉盆



6510-TA-8000
590*395*135mm



6510-K2-8000
695*360*125mm



6510-TB-8000
470*145mm



6510-TC-8000
510*400*120mm



6510-TD-8000
510*420*200mm



6510-X1-80CP
465*465*130mm



6510-X2-80CP
800*465*150mm



6510-J1-8000
370*240*140mm

嵌入式一體盆



6510-F1-8000
765*465*170mm



6510-F2-8000
910*465*160mm



6510-F6-8000
820*465*170mm

半嵌入式臉盆



6510-F3-8000
600*460*165mm



6510-F4-8000
755*460*175mm



6510-TG-8000
400*220*110mm



6510-F8-8000
610*480*210mm

下嵌式臉盆



6510-T8-8000
560*390*210mm



6510-T7-8000
510*420*200mm



6510-T9-8000
450*345*140mm



6510-F5-8000
530*340*172mm



Toilet



6373-01-8000



6373-P1-8100(含面板)



6370-G3-8000
6370-G4-8000
360*690*760mm

洗淨方式：雙孔噴射虹吸式
沖水方式：上壓二段式沖水
進水位置：左進水
排水管距：G3為300mm
G4為400mm



6371-A0-8000
500*370*392mm



6371-K0-8000
520*350*377mm

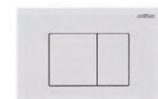

6373-K1-8000(象牙白)



6373-K2-8000(象牙白)



6373-K3-8007(玻璃白)



6373-K1-80CP(電鍍銀)



6373-K2-80CP(電鍍銀)



6373-K3-8031(玻璃霧黑)



6373-K1-80SD(霧銀)



6373-K2-80SD(霧銀)



6373-K4-80S1(不鏽鋼刷線)



6373-K1-80MA(霧黑)

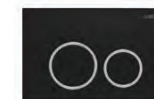

6373-K2-80MA(霧黑)



6373-K4-81S1(不鏽鋼刷線)



6373-K1-80PK(亮金)



6373-K2-80PK(亮金)

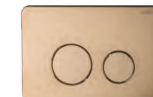

6373-K4-80KG(霧金)

Tissue Holder



6997-42-80CN



7997-42-80CY



6997-H3-80CN
平台(霧銀)
340*140*80mm



6997-H3-80CY
平台(象牙白)
340*140*80mm



6997-H3-80MA
平台(霧黑)
340*140*80mm

衛生紙架



6997-41-80MA
平台捲紙架(霧黑)
250*140*80mm



6997-41-80CN
平台捲紙架(霧銀)
250*140*80mm



6997-41-81MA
平台捲紙架(霧黑-雙圓角)
250*128*80*R15mm



6997-41-81CN
平台捲紙架(霧銀-雙圓角)
250*128*80*R15mm



6997-42-80MA
平台雙捲紙架(霧黑)
340*140*80mm



6997-42-80CN
平台雙捲紙架(霧銀)
340*140*80mm



6997-42-80CY
平台雙捲紙架(象牙白)
340*140*80mm



6997-42-81CN
平台雙捲紙架(霧銀-雙圓角)
340*128*80*R15mm



7478-41-81MA
平台捲紙架(霧黑-雙圓角)
180*120*83mm



7478-41-81S1
平台捲紙架(霧銀-雙圓角)
180*120*83mm



7478-42-81MA
平台雙捲紙架(霧黑-雙圓角)
300*120*83mm



7478-42-81S1
平台雙捲紙架(霧銀-雙圓角)
300*120*83mm

Bathtub



人造石獨立浴缸



6360-M1-8000
170*85*53cm



6360-M2-8000
160*75*56cm



6360-M3-8000
150*82*58cm



6360-M5-8000
170*70*55cm



6360-M6-82CP
170*70*58cm
(含四合一浴缸排水龍頭)



0360-G0-7900
172.5*84.5*60.5cm

壓克力獨立浴缸



6360-D1-8500
150*80*60cm



6360-D2-8500
150*80*60cm



6360-D9-8300
130*80*70cm



6360-D8-8500
150*80*60cm



6360-G1-8500
150*80*60cm

立式浴缸龍頭



6771-U1-80CP
立式浴缸龍頭
(蛇管花灑另規劃)



6771-U1-80MA
立式浴缸龍頭
(蛇管花灑另規劃)



6771-U1-80PK
立式浴缸龍頭
(蛇管花灑另規劃)



6903-U1-80CP
立式浴缸龍頭



6926-U1-80CP
立式浴缸龍頭



6796-U1-91P1
立式浴缸龍頭

Bathtub



四合一浴缸龍頭



6360-M7-8000

- B:140*80*75cm
- C:150*80*75cm
- D:160*80*75cm
- E:170*80*75cm
- F:181*85*75cm



6360-E0-8000

- BC:140*75*51cm
- CC:150*75*51cm
- CD:150*80*51cm
- CE:150*85*51cm
- DC:160*75*51cm
- DD:160*80*51cm
- EC:170*75*51cm

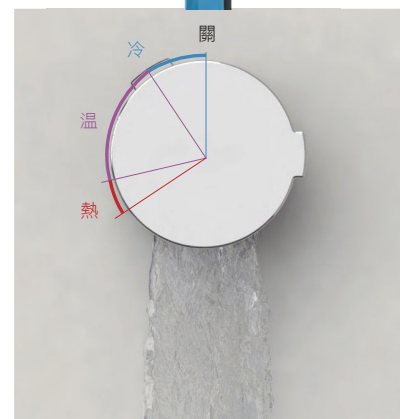

6234- 0-80CP
四合一浴缸龍頭

6234- 0-81CP
四合一浴缸龍頭+接頭

6234- 0-82CP
四合一浴缸龍頭+接頭+編織管

Hand Shower

塑膠手持花灑



金屬手持花灑



0808-9S-79CP

0876-9S-79CP

6877-H1-80CP

0808-9S-79NS



6877-H3-80MA

0808-9S-79MA

6877-H1-80MA

6877-H2-80MA



0759-9S-79CP

0922-9S-79CP

0919-9S-79CP

0875-9S-79CP



6703-9S-80CP



6703-9S-80PK



6771-9S-80CP



6757-9S-80CP(銅)
6770-9S-80S1(不鏽鋼)



6909-9S-80CP



6903-9S-80CP



6903-9S-80CW



6920-9S-80CP



0904-9S-79CP



6877-S1-8034



6877-S1-80CW

Rainshower



出水管



6909-AA-81CP
出水管



6703-A8-80CP
出水管



6909-AR-80CP
出水管

金屬頂噴花灑



6703-AC-80CP
Ø200mm



6770-AC-80S1
6771-AC-80CP
8"



6771-A3-80MA
Ø300mm



6779-AC-80CP
300*200mm



6920-AC-80CP
232*129mm



6909-AC-80CP
8"



6929-A2-80CP
250*250mm
6929-A3-80CP
300*300mm



6808-A1-80CP Ø200mm
6808-A2-80CP Ø250mm
6808-A3-80CP Ø300mm



6768-AC-80CP
8"



6903-AC-8007
250*250mm



6904-AC-80CP
200*200mm



6877-A3-80MA
Ø300mm



6877-B1-80CW
250*190mm



6770-A1-80S1 Ø200mm
6770-A2-80S1 Ø250mm
6770-A3-80PB Ø300mm
6770-A5-80PB Ø500mm



6919-A1-80PB 200*200mm
6919-A4-80PB 400*400mm
6919-A5-80PB 500*500mm

塑膠頂噴花灑

Slide Bar Set

升降桿

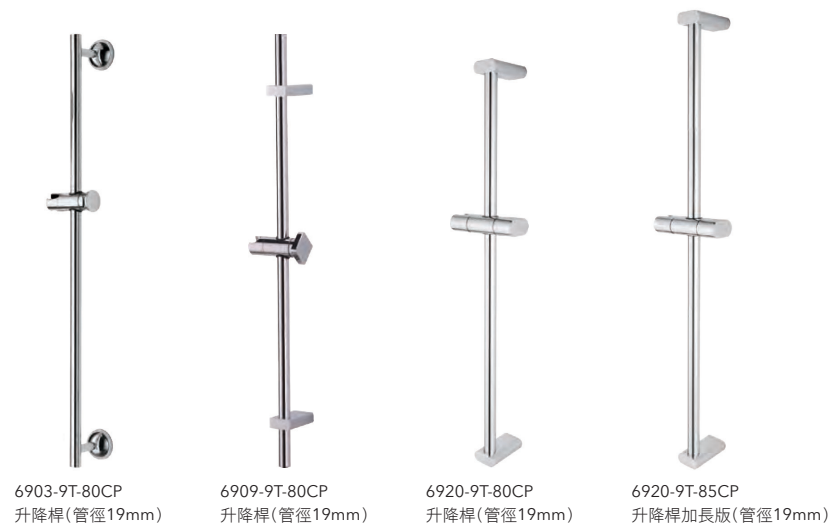
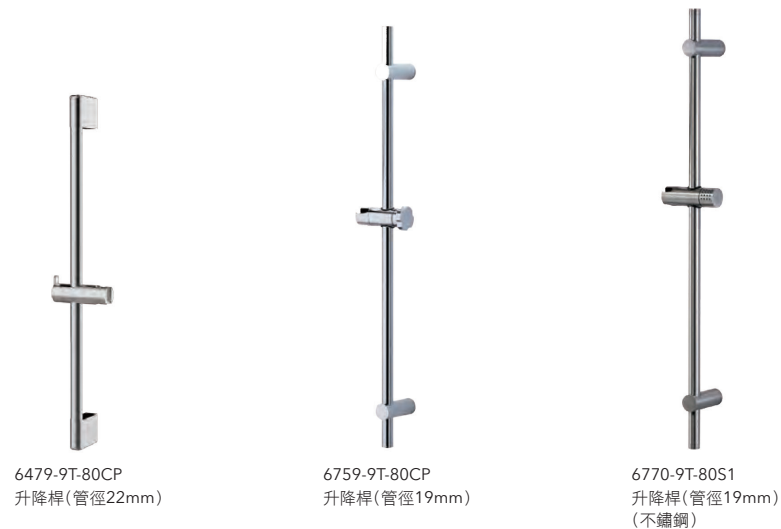

Wall Bracket

花灑掛架



6703-9C-80CP
固定式掛架



6757-9C-80CP
可調式掛架



6767-9C-80S1
可調式掛架
(不鏽鋼)



6796-9C-80CP
固定式掛架



6903-9C-80CP
可調式掛架



6903-9C-80CW
可調式掛架



7703-9C-80CP
可調式掛架



7927-9C-80CP
可調式掛架



0765-9C-79CP
三段式固定掛架
(塑膠電鍍)



0758-9C-7900
固定掛架
(塑膠)



0758-9C-79CP
固定掛架
(塑膠電鍍)



0759-9C-79CP
可調式掛架
(塑膠電鍍)



6909-9C-80CP
固定式掛架



6998-9C-80CP
固定式掛架
(不鏽鋼電鍍)



6998-9C-80S1
固定式掛架
(不鏽鋼)



7777-9C-80CP
可調式掛架



7909-9C-80CP
可調式掛架

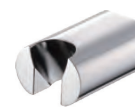

7920-9C-80CP
可調式掛架

Floor Drain

地漏

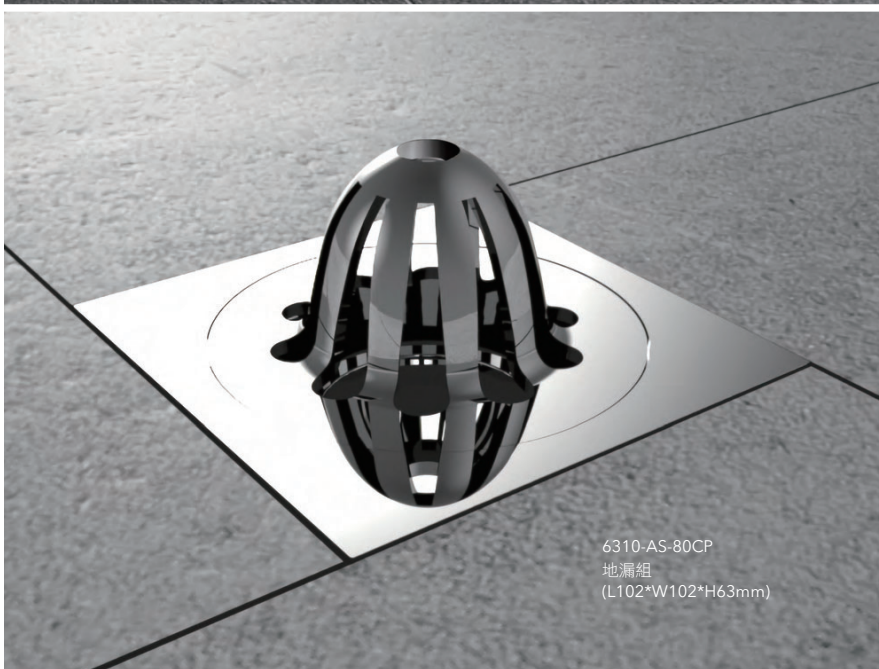
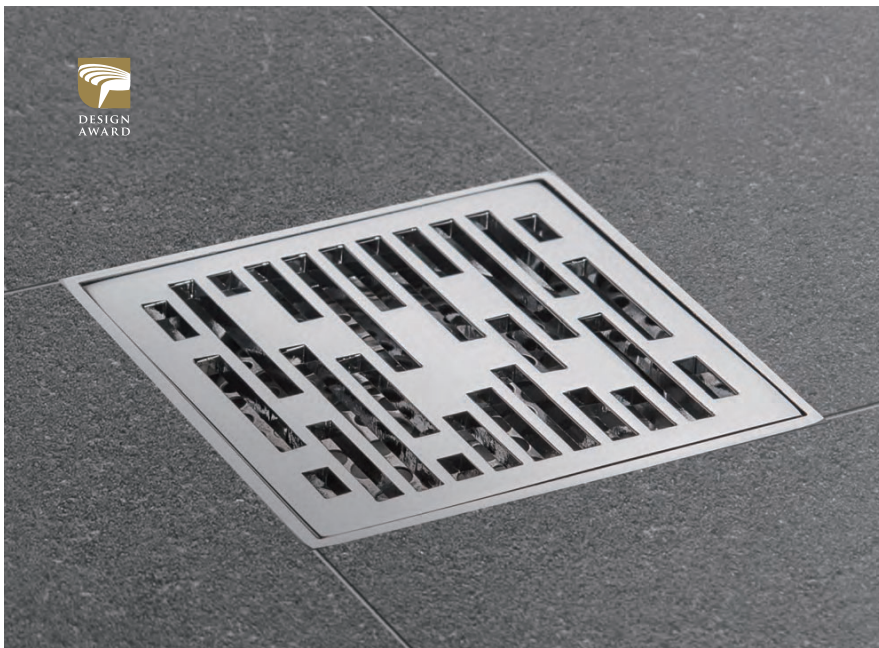

6310-AS-80CP
地漏組
(L102*W102*H63mm)



6310-10-80CP
地漏組
(L100*W100*H35mm)



6310-10-80KG
地漏組
(L100*W100*H35mm)



6310-10-80PK
地漏組
(L100*W100*H35mm)



6310-10-80AB
地漏組
(L100*W100*H35mm)



6310-10-80MA
地漏組
(L100*W100*H35mm)



6310-60-80CP
地漏組
(L100*W100*H35mm)



6310-60-80KG
地漏組
(L100*W100*H35mm)



6310-60-80PK
地漏組
(L100*W100*H35mm)



6310-60-80AB
地漏組
(L100*W100*H35mm)

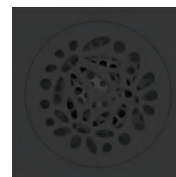

6310-60-80MA
地漏組
(L100*W100*H35mm)



6311-10-80S1
地漏組
(L102*W102*H34mm)



6310-A0-8000
地漏芯

Floor Drain

隱藏式地漏

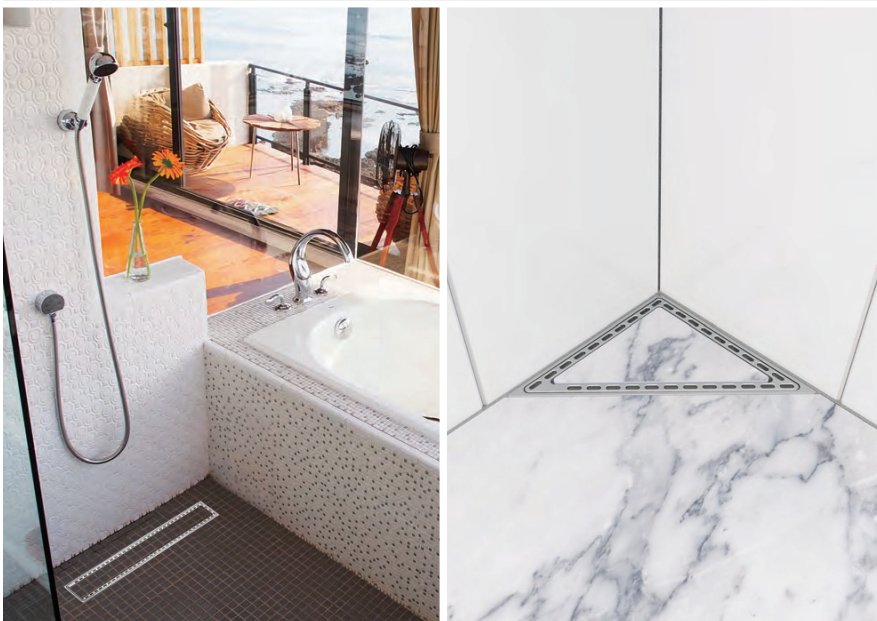
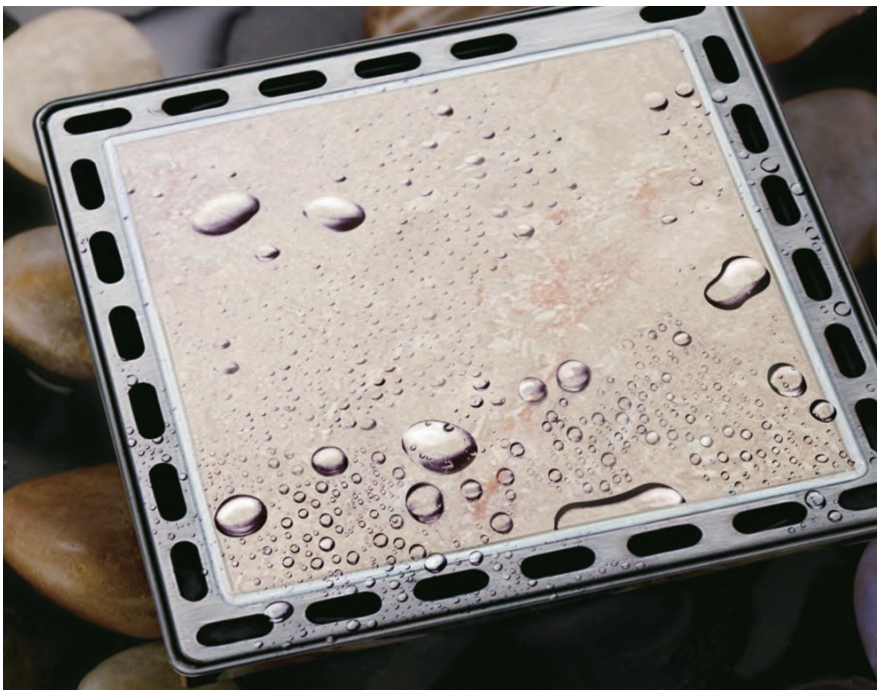

0306-10-79S1
地漏組
(SUS 304)
(L125*W125*H65mm)

6305-A1-7900
地漏芯

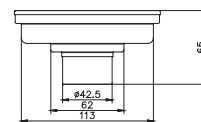

0306-12-79S1
地漏組
(SUS 304)
(L102*W102*H65mm)

6305-A1-7900
地漏芯

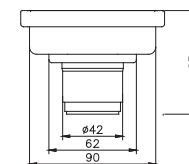

6310-29-79S1
地漏組
(SUS304)
(L200*W200*H57mm)

6305-A2-7900
地漏芯

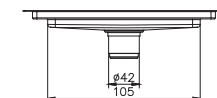

0306-54-79S1
地漏組(SUS 304)
(L527*W127*H65mm)

6306-A2-7900
地漏芯



0306-60-79S1
地漏組(SUS 304)
(L600*W80*H60mm)

6306-A3-7900
地漏芯

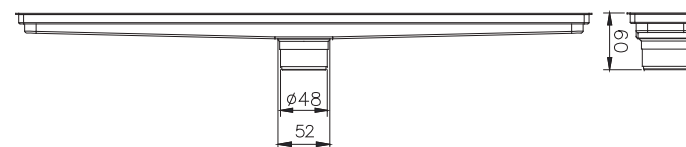

Plumbing Fittings



蛇管



排水管



落水頭



水道零件

